



AX10
SPOTMAX™

User Manual



1 CONTENTS

2	Package Contents.....	3
3	Safety and Handling.....	3
3.1	Bracket.....	4
3.2	Battery.....	4
3.3	Battery Icon and Status LED.....	4
3.4	Charging.....	5
3.5	AC Wiring.....	5
3.6	Diffusors.....	6
4	Specification.....	7
5	Troubleshooting.....	7
6	Operation.....	8
6.1	AsteraRGB Color Space.....	8
6.2	Ways to Control.....	9
6.3	Control By Infrared with ARC1.....	9
6.4	Control by the AsteraApp™.....	10
6.5	Control by Wireless DMX.....	10
6.6	Control Panel.....	11
6.7	Status Screen.....	11
6.8	Main Menu Options.....	12
6.9	Menu Shortcuts.....	12
6.10	INPUT SELECT.....	13
6.11	Select a Static Color.....	14
6.12	DMX Settings.....	15
6.13	DMX FAIL.....	18
6.14	RUNTIME.....	18
6.15	UNPAIR CRMX.....	19
6.16	STANDALONE.....	20
6.17	AC FAILURE (EMERGENCY LIGHT).....	21
6.18	INFO.....	22
6.19	RESET SETTINGS.....	22
7	Using the Light with the AsteraApp™.....	23
7.1	Pair your Light with the AsteraApp™.....	23
7.2	Powerful Light Control.....	24
7.3	Change the Color.....	24
7.4	Create a Set.....	25
7.5	Targeting Lights.....	26
7.6	Changing The Effect.....	27
7.7	List of Effects.....	28
7.8	Chaser Effects in Deep.....	29
7.9	The Main Screen.....	30
7.10	Brightness.....	31
7.11	RUNTIME.....	32
7.12	Anti-Flicker.....	32
7.13	Theft Alarm.....	33
7.14	Enter and Leave Standby.....	34
7.15	DMX Settings.....	35
8	Menu Overview.....	36



This instruction manual is part of the device and persons operating the device must have access to it at any time.

Safety precautions mentioned in the instruction manual have to be observed.

If the device is being sold, this instruction manual has to be included.

This manual is valid for lights with firmware version 5.2.20 and up.

Translations

If the device is being sold, this instruction manual has to be translated into the national language of the destination country.

If discrepancies occur in the translated text, the original instruction manual has to be used to solve them for the manufacturer has to be contacted.

Contact Information

Astera LED Technology GmbH

Karl-Schmid-Str. 14
81829 Munich
Germany

+49 89 2155253-0

Technical support

Europe: +49 89 21552253-1

America: +1 774 247-0437

Asia: +86 755 28237295

Email: service@astera-led.com

2 PACKAGE CONTENTS

- SpotMax™
- Wide Angle Diffuser (32°)
- Wallwash Diffuser (17° x 46°)
- Powercon True1 Power Cord
- Quickstart Manual



3 SAFETY AND HANDLING

Before you operate this unit read the manual carefully. Always make sure to include the manual if you pass/rent/sell the unit to another user. Keep in mind that this manual cannot address all possible dangers and environments. Please use your own caution when operating. This product is for professional use only. It is not for household use.



Do not operate the unit in areas of high temperature conditions or under direct sunlight. It will cause abnormal function or damage the product.



Only qualified personnel may repair this product. Do not open the product housing.



Do not directly look into the light beam. It can cause harm to your eyes. Do not look at the LEDs with a magnifying glass or any other optical instrument that may concentrate the light output. Use only Astera approved accessories to diffuse or modify the light beam.



The exterior surfaces of the light can become hot, up to 70°C (158°F) during normal operation. Ensure that accidental physical contact with the device is impossible. Allow all lights to cool before servicing.



A rechargeable lithium ion battery is built into this unit. Please avoid bumping or plunging, it may cause fire or explosion. Never store the battery when fully drained. Always recharge immediately when empty. Make sure to fully charge all units before storing them. Partially charged batteries will lose capacity. Fully recharge every 6 months if not used.



Always charge with the flight case open. It is recommended to charge at a temperature between 0°C and 35°C



The light contains a lithium ion battery. Don't throw the unit into the garbage at the end of its lifetime. Make sure to dispose is according to your local ordinances and/or regulations, to avoid polluting the environment!

The packaging is recyclable and can be disposed.

3.1 BRACKET

The AX10 SpotMax™ is fitted with a foldable bracket. This is beneficial for storage, transportation, and charging as the legs fold parallel to each other. It allows easy carrying, too, with the ergonomic handle.

The handle also contains a W 1/2" thread to attach the Super Bolt (which then can be attached to Manfrotto Super Clamps). The bolt can be ordered separately.

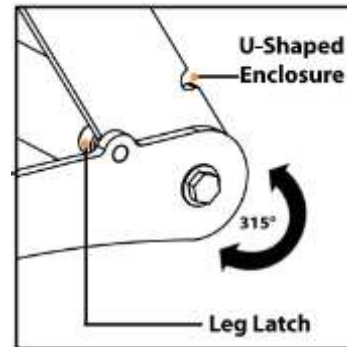

3.2 BATTERY

While running on battery, the light adjusts its output to meet the required minimum runtime. It can be set by the control panel (6.14 R) or the AsteraApp™ between one and twenty hours.

The battery is specified to last for 300 full discharge cycles. Its runtime will have decreased to 70% by then. To increase the battery life it is recommended to recharge as early as possible and not let the light run until the battery is depleted.

If operated below 20°C, the battery runtime may be slightly shorter than predicted. This is also true if the lights are stored for a long time at cold temperature right before they are used.

The light is constantly monitoring the LED temperature and dims down the brightness if it exceeds 65°C. That ensures a save and long-live operation but in a hot environment the brightness might be slightly lower.

NOTE:

Always store the lights with full battery.

Depleted batteries must be recharged immediately, otherwise their performance will suffer.

ATTENTION:

The battery may be only replaced with an original Astera replacement battery.

3.2.1 STANDBY

By using the AsteraApp™, the light can be set to a special standby mode.

In that mode, its output is switched off, the CRMX receiver is powered down and it enters a state of low power consumption.

A full battery will supply the SpotMax™ roughly 20 days in standby mode.

To light leaves the standby mode if the ENTER key is pressed or the standby mode is left by the AsteraApp™.



3.3 BATTERY ICON AND STATUS LED

The Battery Status LED is designed for being used before an event. All fixtures should have a green Status LED to ensure that the battery lasts for your upcoming event. If it is another color, recharging is recommended.

While the light is connected to AC, the Status LED will be blue. While it is charging, the Battery Icon will start the charging sequence. Once the battery is fully charged the battery icon on the display will show all 3 bars (as below). If the battery is already fully charged and the power cord is plugged in, the display will show a battery with moving bars for approx. 30-60 seconds after which it will stop and the icon will show a full battery.



-  Less than 30mins runtime remaining; recharge
-  Over 30mins runtime have been used

-  Up to 30mins runtime have been used
-  Connected to AC

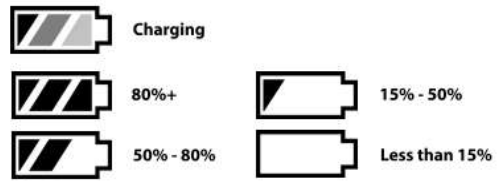

3.4 CHARGING

Charge the light immediately after use.

If charged in a flight case, make sure it is open. It is recommended to charge the lights at an ambient temperature between 0°C and 35°C. A normal charge cycle will take five to seven hours, but may take much longer if the light is hot.

The light is designed to be charged while powered off. If it is connected to AC and powered on, it may charge at reduced current if enough power is available and the battery temperature is below 45°C.

The light has an automatic battery bypass switch, so it can safely be used wired, this will not cause wear to the battery.

3.5 AC WIRING

The light is equipped with Neutrik True1 Powercon input and output connectors. They are rated IP65 even while a connector is plugged in.

3.6 DIFFUSORS

The effect of the diffusers can be seen below:

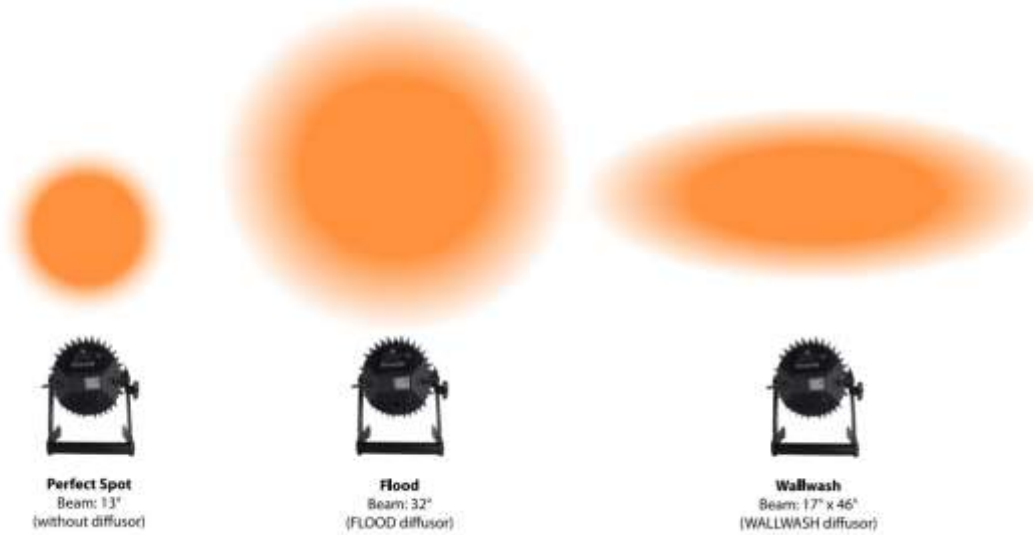

NOTE: Each diffuser has its name inscribed on the edge (FLOOD or WALLWASH).

In order to **attach the diffuser**, the diffuser must be slid into the Diffusor Slots, then pressed down firmly and clipped in under the Diffusor Clip.

In order to **remove the diffuser**, the Diffusor Clip should be pressed in and the diffuser sheet should be lifted out via the Thumb Hole.

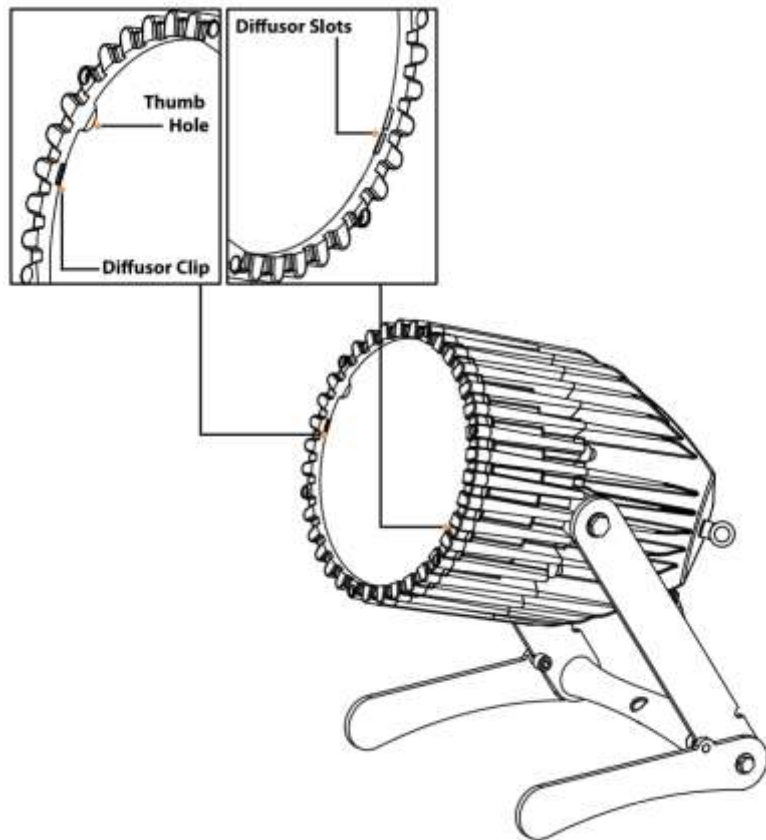



4 SPECIFICATION

LED power:	135W
Illuminants:	9 x 15W RGBAW Philips LEDs
Luminous Flux*:	3,350lm (at White 4000K)
Emittance*:	10,350lx (at 2m; White 4000K)
CRI*:	up to 92
Beam Angle:	13°
Input Voltage:	90-264V 47-63Hz 1.8A/115VAC 1.0A/230VAC
Inrush Current:	COLD START 70A/230VAC
Battery Runtime:	up to 20hrs (seamless runtime)
Wireless Module:	EU: 868.0-869.7 MHz US: 902-928 MHz 2.4 GHz
Operating Temperature:	0°C – 40°C 32°F – 104°F
Relative Humidity:	0%-100%
Size:	L279mm x W253mm x H296mm 10.9" x 11.6" x 9.9"
Weight:	7.98 kg 17.5lbs
IP Rating:	IP65

* Typical Values

5 TROUBLESHOOTING

The fixture does not turn on.

The battery may be empty. Connect it to the AC and try again.

The fixture turns on and the display is on, but the LEDs do not emit light.

The fixture could be set to BLACKOUT mode, set to display black color or is operating in DMX mode and doesn't receive a valid signal. It is good practice to do a RESET SETTINGS (Chapter 6.19) between setups.

The fixture is not working correctly - it does not display the color or effect chosen.

The fixture may still be operating under a previous setting. It is good practice to do a RESET SETTINGS (Chapter 6.19) between setups.

After completing a RESET SETTINGS, the fixture still cannot be controlled by AsteraApp™.

Make sure the RADIO PIN (Chapter 6.18) of the fixture and AsteraApp™ is the same.

The fixture does not run long enough on battery.

The required RUNTIME can be set. It defaults to 5h. To achieve a greater battery runtime, set the RUNTIME to the required value. Alternatively, program the fixture to only display colors that use less power, such as Red, Green and Blue.

If the runtime is still too short, consider that it is reduced slightly if the battery is very cold.

The power cable is connected but the fixture is not charging.

The battery may be fully charged. Refer to chapter 3.2.1 for more details. The fixture will only commence charging when its battery has a temperature of 45° or less. Turn the fixture off and let it cool down; once cold enough, it will start charging. If it still not charging, consult our website.

6 OPERATION

6.1 ASTERARGB COLOR SPACE

The lights work with a specially optimized RGB color space, the AsteraRGB color space. It is designed to eliminate the need to control each color individually to display a certain color. Instead, the light calculates the optimum combination of all colors based on an RGB value. It considers each LED chip's temperature as well as an optimal color rendering.

Due to this, it is possible to reproduce colors with high accuracy. It is possible to calculate an AsteraRGB representation for any CIE color. The easiest way to do this is with the AsteraApp™:

- Go to the color picker and add a new favorite color
- Go to favorite colors and edit it

The dialog on the right will open.

It allows you to find AsteraRGB values for a certain color temperature. S-RGB or CIE1931 values can be calculated to AsteraRGB by pressing the corresponding buttons.

The primaries of the AsteraRGB are defined as:

Red		Green		Blue	
x_R	y_R	x_G	y_G	x_B	y_B
0.7079	0.2920	0.1750	0.7200	0.1566	0.0177

White Point	
x	y
0.4917	0.4878



The light also includes the Dynamic Powerboost feature. It ensures that colors that consume less electrical power are boosted slightly, while power power-consuming colors are slightly compressed.

This maximizes the brightness while maintaining the desired battery runtime.

While controlling with the AsteraApp™ or by the Control Panel, only RGB values can be set.

By DMX control, it is possible to control all colors separately. But it should be noted, that then temperature compensation is only available for Red, Green and Blue; all other colors will experience temperature drift, their brightness will not be constant.

6.2 WAYS TO CONTROL

The light can be controlled in several ways:



Use Astera's ARC1 infrared remote control, point it at individual lights and press the desired effect. Note that the IR sensor is on the AX10's rear side.



The AsteraApp™ is an efficient way to quickly create a customized light show. It can group several lights together, address individual lights or groups of lights, and send complex effects with a user defined color palette to all lights in range. For additional information refer to chapter 7. Alternatively, the Astera ARC2 remote control can be used.



The light can also be controlled by CRMX wireless DMX, the built in receiver is compatible with all LumenRadio CRMX transmitters as well as W-DMX™ G2, G3, G4 and G4S transmitters (G4 and G4S in 2.4 GHz mode only).



You can also use an Astera ART3 Wireless DMX Transmitter to send DMX in the UHF frequency band, although CRMX is the recommended method.



Power the light on/off, set a static color or change its settings.

CRMX is a trademark of LumenRadio AB

W-DMX is a trademark of Wireless Solution Sweden AB

6.3 CONTROL BY INFRARED WITH ARC1

The light can be controlled by the infrared remote control if:

- INPUT SELECT is set to AUTO or REMOTE CONTROL (refer to chapter 6.10).
- The light is currently NOT operated by DMX. If it is, only ON and OFF will work while INPUT SELECT is set to AUTO.



The ARC1 is very handy to switch several lights on or off at a time.



6.4 CONTROL BY THE ASTERAAPP™

Your light has a built in standalone engine. It can display static colors or replay a number of predefined effect patterns with a customizable color palette.

With the AsteraApp™ these effects can be created and be sent to the light by the built in UHF receiver. The effects are just triggered and then each light replays it autonomously until it receives a new effect.

Lights can be grouped into sets. This way they can be controlled separately and also effects can stretch over up to 32 lights.

Also, you can remotely adjust your lights settings, this eases DMX setup for example.

For more details refer to chapter 7.

6.5 CONTROL BY WIRELESS DMX

To pair your light to a CRMX or W-DMX™ transmitter, make sure that:

- Your light is not currently paired to a transmitter. To unpair it refer to chapter 6.15.
- INPUT SELECT is either set to AUTO and the light is still in detect mode –or- INPUT SELECT is set to CRMX wireless DMX; for details refer to chapter 6.10.





Then press the button on your transmitter. After 10 seconds the light should be paired and show the appropriate status screen (chapter 6.7).

If you prefer to use an Astera ART3 wireless transmitter, set INPUT SELECT to Astera wireless DMX and refer to the ART3's user manual for details.

NOTE:

If you experience difficulties pairing your light, it is recommended to set INPUT SELECT to CRMX wireless DMX first. This will make sure that the CRMX status screen is displayed.

6.6 CONTROL PANEL

LEGEND			
			
BACK TO PREVIOUS MENU	SCROLL DOWN	SCROLL UP	CHOOSE/ CONFIRM
FROM THE STATUS SCREEN, PRESS THE ABOVE BUTTONS TO:			
ENTER THE MAIN MENU	FACTORY RESET	ENTER THE MAIN MENU	ENTER THE DMX MENU
HOLD THE ABOVE BUTTON FOR 2SECS TO:			
STANDALONE MENU	ADJUST SPEED	ADJUST BRIGHTNESS	CHANGE PROGRAM

6.6.1 Blue Mode

Blue mode is an easy way to pair your light with the AsteraApp. To enter Blue Mode, hold down the POWER button for 3 seconds while the light is switched on. It will start to flicker blue.

6.7 STATUS SCREEN

The status screen is shown after power up. The light also returns to the status screen if no keys are pressed for three minutes.

It shows:

- In the FIRST line what input is currently active
- In the SECOND line the current DMX and SET address

INPUT: DETECTING SET: 001 DMX: 001	INPUT SELECT is set to AUTO and the light did not yet latch to one input source.
REMOTE CONTROL SET: 001 DMX: 001	The light is latched to REMOTE CONTROL mode.
STANDALONE SET: 001 DMX: 001	INPUT SELECT is set to STANDALONE. The light can no longer be controlled by any wireless signal.
CRMX: SIGNAL 99% SET: 001 DMX: 001	The light is latched to CRMX mode.
WLDMX: NO LINK SET: 001 DMX: 001	The light is latched to Astera wireless DMX mode.
EMERGENCY LIGHT SET: 001 DMX: 001	Emergency light mode can be active because either AC FAIL or DMX FAIL being set to EMERGENCY LIGHT.
STANDBY SET: 001 DMX: 001	The standby mode saves power; the light is off and waiting for a "leave standby" command received by the AsteraApp™.
ALARM DO NOT STEAL THI	Theft alarm is active.
ACCEPT CONFIG ? SET: 001 DMX: 001	If the AsteraApp is asking to "tap a light" and this is shown, press the ENTER key shortly to accept.



6.8 MAIN MENU OPTIONS

The main menu can be entered from the status screen by pressing MENU or +. To cycle between the main menu entries, press the + or – keys. Pressing MENU again will go back to the status screen.

Main menu: INPUT SELECT	Used to change the input source or set it to AUTO.
Main menu: STATIC COLOR	Entering this menu resets all STANDALONE settings to default and makes the light display a static color.
Main menu: DMX ADDRESS	Set the DMX address.
Main menu: DMX SETTINGS	Set the DMX parameters.
Main menu: UNPAIR CRMX	Unpair from a CRMX or W-DMX™ transmitter.
Main menu: RUNTIME	Set the lights runtime on battery in hours.
Main menu: STANDALONE	Set parameters of the standalone engine.
Main menu: AC FAILURE	The light can react to the loss of AC power input.
Main menu: INFO	Information about the light: radio pin, firmware version, battery status, ect.
Main menu: RESET SETTINGS	Reset all user settings to default. Should be done after each usage to ensure consistent behavior. The RADIO PIN is NOT reset.

6.9 MENU SHORTCUTS

To get to the DMX address setting, press the ENTER key twice from the status screen.

To open the DMX settings menu, press ENTER, then the + key and ENTER again.

To reset the light to default settings, press the – key, then ENTER and again ENTER.

6.10 INPUT SELECT

The light accepts several input sources. By default, it is set to AUTO. In this mode, it listens to all sources, and the first source that becomes active is latched. Once a source is latched, the light will not listen to any other source anymore.

This latched source is cleared by powering down the light or changing the INPUT SELECT manually.

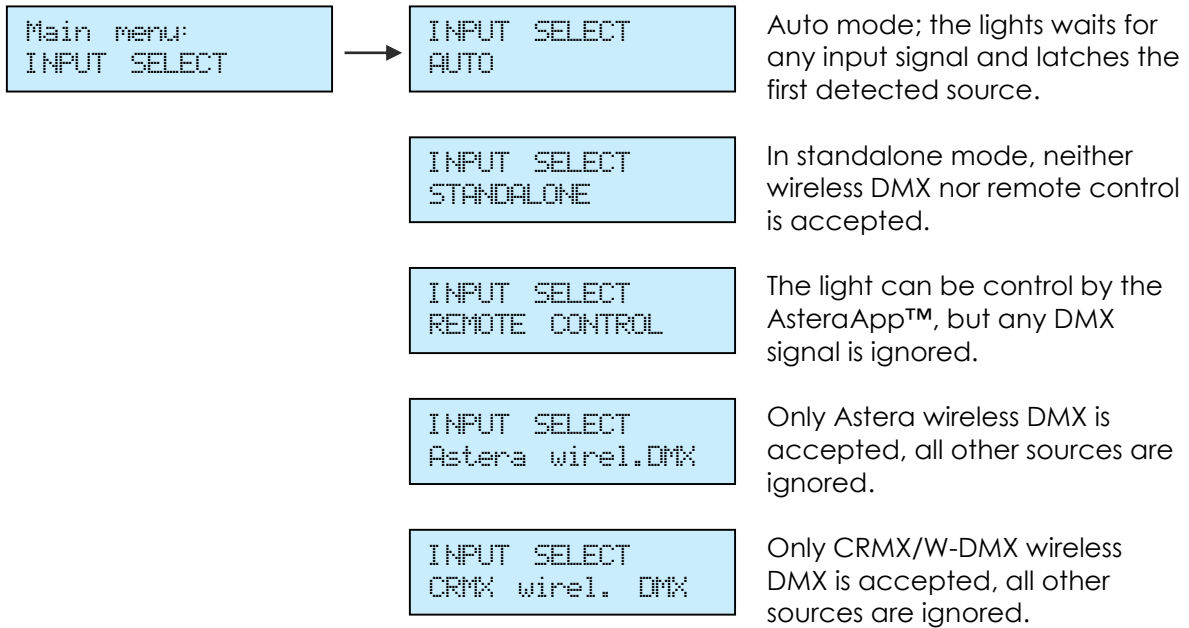

The following table shows what sources are accepted for each setting:

Source	INPUT SELECT									
	AUTO, none latched	AUTO, STANDALONE latched	AUTO, REMOTE CONTROL latched	AUTO, Astera wirel. DMX latched	AUTO, CRMX wirel. DMX latched	STANDALONE	REMOTE CONTROL	Astera wirel. DMX	CRMX wirel. DMX	
AsteraApp™: change colors	•		•				•			
AsteraApp™: STANDBY, RUNTIME, ALARM	•	•	•	•	•		•			
AsteraApp™: DMX Settings	•	•	•	•	•		•	•	•	
Astera Wireless DMX	•			•				•		
CRMX Wireless DMX	•				•				•	
Infrared Remote	•	•	•	•	•		•			
The Light's Control Panel	•	•	•	•	•	•	•	•	•	

HINT:

To avoid the light automatically latching onto CRMX while you want to control it by remote control, please do UNPAIR CRMX (chapter 6.15). As soon as the remote control is latched, the CRMX receiver will no longer accept pairing requests.

6.11 SELECT A STATIC COLOR

To make the light show a static color, enter this menu. Immediately when it's entered, all previous STANDALONE settings are cleared to default and the INPUT SELECT is latched to STANDALONE. This is valid until the next power-up only. To make sure the light also shows a static color after the next power up, set INPUT SELECT to STANDALONE and not AUTO.

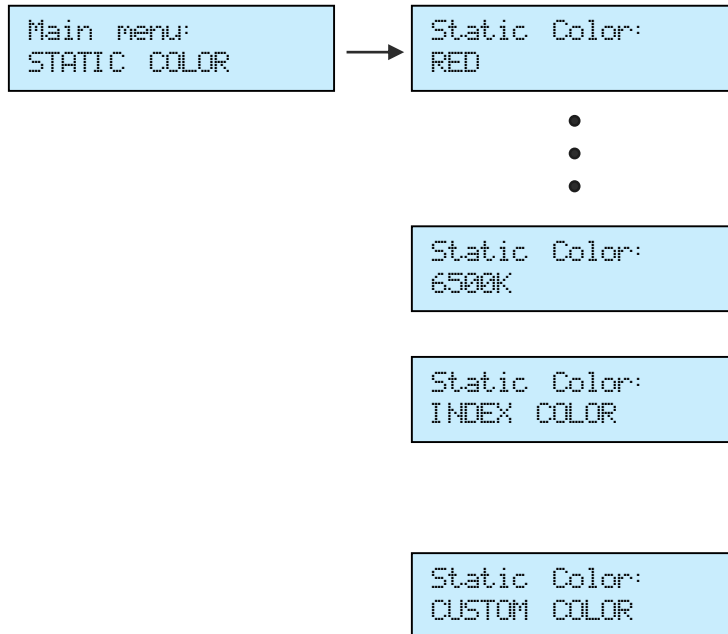

A number of predefined colors are available while scrolling through the menu. See below for a full table.

By entering the INDEX COLOR menu, a number of predefined colors similar to those of common gels are available for selection.

To set a color by its red, green and blue value, enter here.

6.11.1 Predefined Colors

Color	Red	Green	Blue
RED	255	0	0
ORANGE	255	107	0
YELLOW	255	160	18
GREEN	0	255	0
CYAN	0	255	224
BLUE	0	0	255
VIOLET	127	84	255
PINK	255	53	119
BLACK	0	0	0
2700K	255	166	70
3200K	255	178	89
4000K	255	193	115
5500K	255	211	150
6500K	255	219	167

6.12 DMX SETTINGS

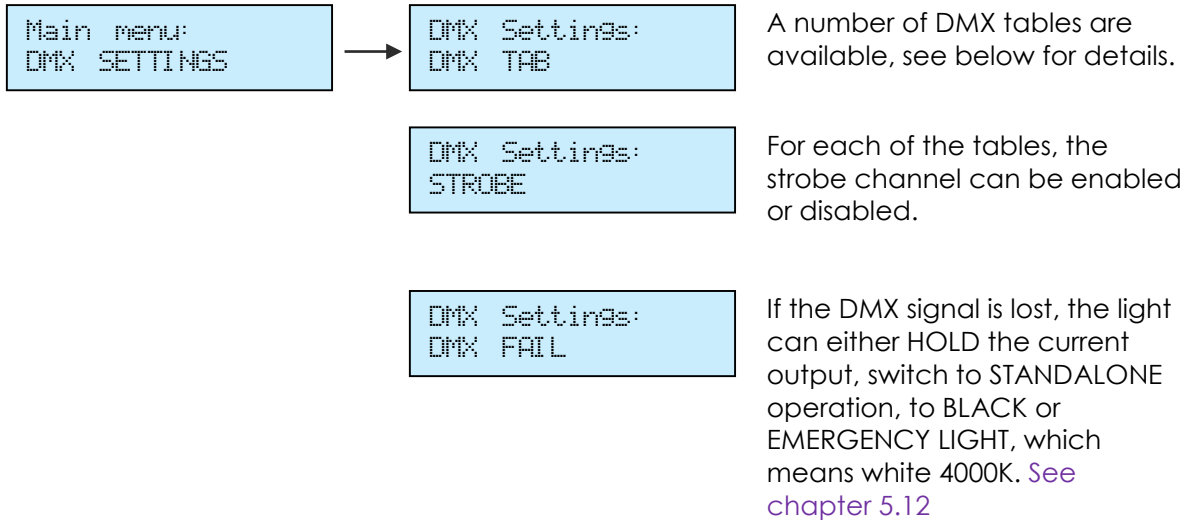

6.12.1 DMX Tables

Each of the tables can optionally contain a strobe channel. It can be switched on or off by the STROBE menu. The tables below list it, but in case it is set to OFF, the DMX-channels are unused.

6.12.1.1 RGB S

CHANNEL	VALUE	FUNCTION
1	0..255	RED
2	0..255	GREEN
3	0..255	BLUE
4		STROBE (only if STROBE is ON)
	0..3	OFF
	4	RANDOM FAST
	5	RANDOM MEDIUM
	6	RANDOM SLOW
	7..255	Variable strobe

6.12.1.2 RGBW S

CHANNEL	VALUE	FUNCTION
1	0..255	RED
2	0..255	GREEN
3	0..255	BLUE
4	0..255	WHITE
5		STROBE (only if STROBE is ON)
	0..3	OFF
	4	RANDOM FAST
	5	RANDOM MEDIUM
	6	RANDOM SLOW
	7..255	Variable strobe

6.12.1.3 RGBAW S

CHANNEL	VALUE	FUNCTION
1	0..255	RED
2	0..255	GREEN
3	0..255	BLUE
4	0..255	AMBER
5	0..255	WHITE
6		STROBE (only if STROBE is ON)
	0..3	OFF
	4	RANDOM FAST
	5	RANDOM MEDIUM
	6	RANDOM SLOW
	7..255	Variable strobe



6.12.1.4 RGB CCT DIM IND S

CHANNEL	VALUE	FUNCTION
1	0..255	RED
2	0..255	GREEN
3	0..255	BLUE
4		COLOR TEMPERATURE (CCT)
	0..4	no effect
	4..255	display color temperature; CCT overwrites the RGB setting
		Formular: $CCT = 2000 + 20 * DMX-Value$
		Example: 50 -> 3000K
		100 -> 4000K
		150 -> 5000K
5	0..255	Dimmer
6		INDEX COLOR
	0..4	no effect
	4..255	display index color (common gels); INDEX COLOR overwrites both, RGB and CCT.
7		STROBE (only if STROBE is ON)
	0..3	OFF
	4	RANDOM FAST
	5	RANDOM MEDIUM
	6	RANDOM SLOW
	7..255	Variable strobe

6.12.1.5 DIM RGB S

CHANNEL	VALUE	FUNCTION
1	0..255	Dimmer
2	0..255	RED
3	0..255	GREEN
4	0..255	BLUE
5		STROBE (only if STROBE is ON)
	0..3	OFF
	4	RANDOM FAST
	5	RANDOM MEDIUM
	6	RANDOM SLOW
	7..255	Variable strobe

6.12.1.6 DIM RGBW S

CHANNEL	VALUE	FUNCTION
1	0..255	Dimmer
2	0..255	RED
3	0..255	GREEN
4	0..255	BLUE
5	0..255	WHITE
6		STROBE (only if STROBE is ON)
	0..3	OFF
	4	RANDOM FAST
	5	RANDOM MEDIUM
	6	RANDOM SLOW
	7..255	Variable strobe

6.12.1.7 DIM RGBAW S

CHANNEL	VALUE	FUNCTION
1	0..255	Dimmer
2	0..255	RED
3	0..255	GREEN
4	0..255	BLUE
5	0..255	AMBER
6	0..255	WHITE
7		STROBE (only if STROBE is ON)
	0..3	OFF
	4	RANDOM FAST
	5	RANDOM MEDIUM
	6	RANDOM SLOW
	7..255	Variable strobe

6.12.1.8 Effect Modes

There are two effect modes available. They offer a comprehensive control of the built in standalone engine. Settings that can otherwise only be changed on the LCD menu or by the AsteraApp™ can be directly adjusted by DMX. The two effect modes only differ in the way the color palette of four colors is set: either by RGB or by a single channel, like a color wheel. In that case, common gels can be selected directly. Strobe is always enabled for the effect modes.

CHANNEL		VALUE	FUNCTION
EFFECT MODE FIX	EFFECT MODE RGB		
1	1	0..255	INTENSITY
2	2		STROBE
		0..3	OFF
		4	RANDOM FAST
		5	RANDOM MEDIUM
		6	RANDOM SLOW
		7..255	Variable strobe
3	3		PROGRAM:
		0..7	ONE COLOR STATIC
		8..15	TWO COLOR STATIC
		16..23	THREE COLOR STATIC
		24..31	FOUR COLOR STATIC
		32..39	ONE COLOR FADE
		40..47	TWO COLOR FADE
		48..55	THREE COLOR FADE
		56..63	FOUR COLOR FADE
		64..71	SIMPLE RUNNING
		72..79	DOUBLE RUNNING
		80..87	TWO COL RUNNING
		88..95	FLAG RUNNING
		96..101	DOUBLE FLAG RUNNING
		102..109	SPIRAL 4 COLOR
		110..117	SPIRAL 2 COLOR
		118..125	RAINBOW
		126..133	FIRE
		134..141	ROTOR
		142..149	ROTOR SPLIT 2
		150..157	ROTOR SPLIT 4
4	4	0..255	SPEED
5	5	0..255	FADE
6	6		DIRECTION:
		0..63	FFW+LOOP
		64..127	FFW
		128..190	REW
		191..255	REW+LOOP
7	7		SIZE:
			Defines the virtual size of the program in groups. For example if SIZE is set to 2 groups, only half of the program is shown on the unit.
		0..63	1 Group
		64..127	2 Groups
		128..190	3 Groups
		191..255	4 Groups
8	8		OFFSET:
		0..255	If SIZE is set to >1 group, the units pixels can be shifted within the virtually larger program. Increasing the OFFSET parameter scrolls the position of the unit within the virtual large program.
9	9	0..255	RESTART PROGRAM
			if value is changed, the program starts again from the beginning (useful if DIRECTION is not set to loop)
10			INDEX COLOR 1
11			INDEX COLOR 2
12			INDEX COLOR 3
13			INDEX COLOR 4
	10		RED 1
	11		GREEN 1
	12		BLUE 1
	13		RED 2
	14		GREEN 2
	15		BLUE 2
	16		RED 3
	17		GREEN 3
	18		BLUE 3
	19		RED 4
	20		GREEN 4
	21		BLUE 4

6.13 DMX FAIL

It can be set what the lights should do when the DMX signal is lost.

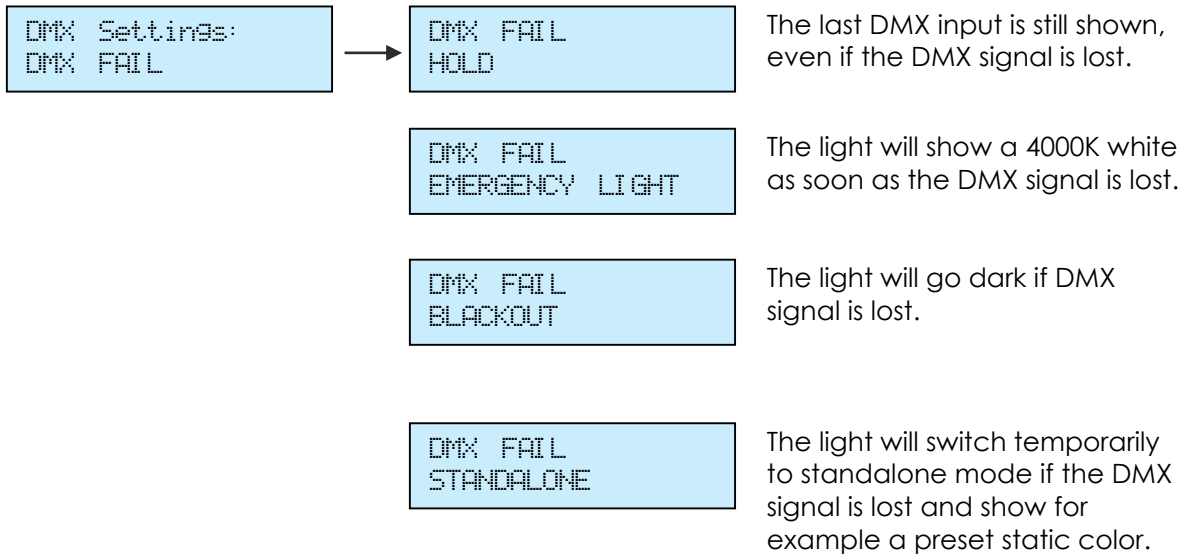

6.14 RUNTIME

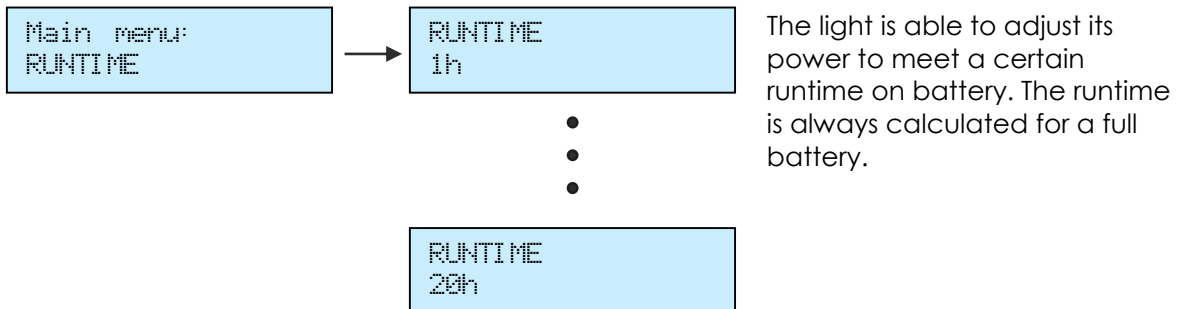

EXAMPLE:

If the light is required to light during an eight hour event, and one hour of setup time is scheduled, then the runtime should be set to nine hours immediately after the first power up.

Please note, that the light should not be stored below 20°C before an event, otherwise the runtime might be shorter than calculated.

More details on the built in battery can be found at chapter 3.2.

For additional power-savings refer to the AsteraApp™ manual.



6.15 UNPAIR CRMX

```
Main menu:  
UNPAIR CRMX
```

Once your light is paired to a CRMX or W-DMX™ transmitter, it cannot be paired to another one until it is unpaired. This can be either done by using the button on the transmitter that is currently paired or on the light directly.

If you wish to unpair your CRMX wireless DMX receiver from a Lumen Radio or W-DMX™ transmitter, go to UNPAIR CRMX and press enter.

NOTE:

The CRMX receiver is only powered while INPUT SELECT is:

- *set to CRMX wireless DMX*
- *or AUTO and either CRMX is latched or no source is latched yet.*

For details in INPUT SELECT refer to chapter 6.10.

6.16 STANDALONE

Main menu: STANDALONE	Standalone: PROGRAM	Select one of the predefined patterns, see table below.
	Standalone: INTENSITY	Sets the dimmer level.
	Standalone: SPEED	The time that one cycle of the program takes to complete.
	Standalone: FADE	The fade behavior between each step of the program. 0% means, no fading 100% means full fading, fade-is directly followed by fade-out.
	Standalone: COLOR C1 • • •	The color palette of the programs consist of up to four colors. They can be set individually. See chapter 6.11 for details on how to set a color.
	Standalone: COLOR C4	
	Standalone: SET ADDRESS	The AsteraApp™ can control sets of lights individually. The set address can be 1 to 254. This setting is normally done by the set-wizard in the AsteraApp™.
	Standalone: SET SIZE	Several lights can form a virtual "big" light. Programs like running light will then run over all those lights one by one. This parameter tells how many lights should form that virtual light; up to 32.
	Standalone: POS IN SET	Tells the lights position in the big virtual light, 1..32.
	Standalone: GROUP ADDRESS	Group addressing is supported by the ARC2, please refer to the ARC2 manual.

6.16.1 Predefined Programs

The predefined programs may use more than one pixel. To display these effects properly with your light, it is first necessary to group them into Flow-Sets and control them by the AsteraApp™ (see chapter 7.4).

If several lights are grouped into a Flow-Set, they form a virtual big light with several pixels.

Name	Pattern
ONE COLOR STATIC	A static color is displayed on the whole virtual light.
TWO COLOR STATIC	The virtual light is split into two halves and two colors are displayed.
THREE COLOR STATIC	The virtual light is split into three parts and three colors are displayed.
FOUR COLOR STATIC	The virtual light is split into four parts and four colors are displayed.
ONE COLOR FADE	For all FADE programs, the whole color palette of four colors is used. Those colors are faded in and out one by one. Here, the whole virtual light shows the same color.
TWO COLOR FADE	The virtual light is split and shows two colors at a time.
THREE COLOR FADE	The virtual light is split and shows three colors at a time.
FOUR COLOR FADE	The virtual light is split and shows four colors at a time.
SIMPLE RUNNING	A running light; the background and the running pixels color can be set.
DOUBLE RUNNING	Two pixels are running in opposite direction.
TWO COL RUNNING	The two pixels are of different color even.
FLAG RUNNING	A three color flag is running over the background color.
DOUBLE FLAG RUNNING	Two flags are running over background in opposite direction.
SPIRAL 4 COLORS	The color is changed pixel by pixel. All four colors are used one after the other.
SPIRAL 2 COLORS	The color changes between color 1 and 2 from the outside to the inside, pixel by pixel.
RAINBOW	A rainbow effect is displayed.
FIRE	The fire effect is a random flicker between two colors, background and flickering color.

NOTE:

It is highly recommended to check out the effects editor of the AsteraApp™ to get a better understanding of how those programs work. Also, many programs look similar if the lamp is NOT grouped into a Flow-Set.

6.17 AC FAILURE (EMERGENCY LIGHT)

The light can react to the loss of AC power in several ways. As soon as AC is present again, the light resumes normal operation.

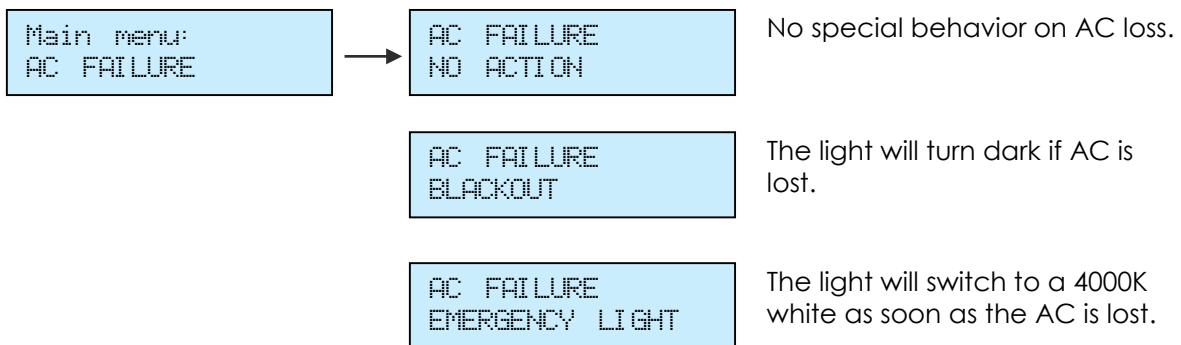

6.18 INFO

Main menu: INFO	→ Radio PIN: 0000	Read/set the RADIO PIN. To change the pin, press ENTER. Adjust each digit with the + and – keys, cycle through the digits with the MENU key. When finished, press ENTER again.
	Serial number: 000-00000 43xx	Tells the serial number of the light and the CPU type (43xx).
	Firmware version 5.2.20.U H0001	The firmware version and hardware version of the light.
	Power-on hours: 00001h	The hour-counter is counting up as long as the light is powered up. It does not count if the light is powered off and charging.
	RF link: -36.0dBm -0.0ppm	While the light is receiving an UHF signal, this tells the signal strength and deviation.
	Battery state: 100%	The current charging state of the battery in percent.
	Calibration: 2015-04-20-0001	Gives information about the LED calibration stored in the light, for service reference only.

6.19 RESET SETTINGS

Main menu: RESET SETTINGS	→ ARE YOU SURE? NO YES	Return the light to the default settings. This may be done before each use to start from a known point. The RADIO PIN and the CRMX pairing stay.
------------------------------	---------------------------	--

HINT

It is highly recommended to reset the light's settings after each event to ensure a clear start for the next usage.

7 USING THE LIGHT WITH THE ASTERAAPP™

The buttons of the AX10 only allow a basic operation of the light. To gain full control over all features, the AsteraApp™ should be used.

The AsteraApp™ is an efficient way to quickly create a customized light show. It can group several lights together, address individual lights or groups of lights, and send complex effects with a user defined color palette to all lights in range.

Additionally, it can be used to adjust the lights settings remotely.

The AsteraBox™ is needed to interface your Android device with the lights. It communicates to the Android device by Bluetooth and controls the lights by UHF.

7.1 PAIR YOUR LIGHT WITH THE ASTERAAPP™

The connection is secured by a 4 digit Radio Pin. Only if the lights pin matches the AsteraApp™ pin, lights are controllable.

The pairing process transmits the radio pin from the app to the light and stores it there.

1. Choose a unique Radio Pin in the app.
2. Switch the light into blue mode, see chapter 6.6.
3. Press the "Pair with Lights" button in the AsteraApp™.

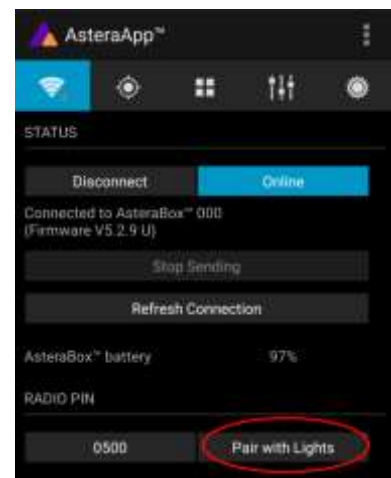

NOTE:

Alternatively, you can set the Radio Pin manually at the Control Panel of the light. Refer to chapter 6.18 for details.

7.2 POWERFUL LIGHT CONTROL

Your light has a built in standalone engine. It can display static colors or replay a number of predefined effect patterns with a customizable color palette.

With the AsteraApp™ these effects can be created and be sent to the light by the built in UHF receiver. The effects are just triggered and then each light replays them autonomously until a new effect is sent.

Lights can be grouped into sets. This way they can be controlled separately and also effects can stretch over up to 32 lights.

7.3 CHANGE THE COLOR

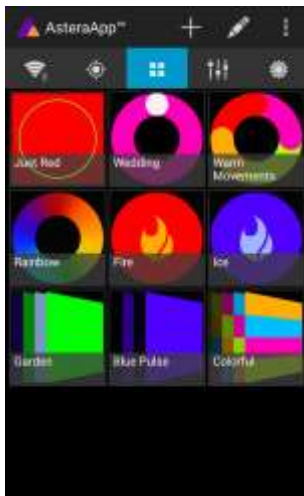

On the AsteraApp™ main screen, press "Just Red".

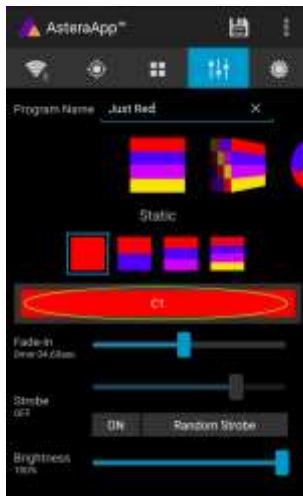

Once in the editor, press "C1".



Now the lights color can be changed.

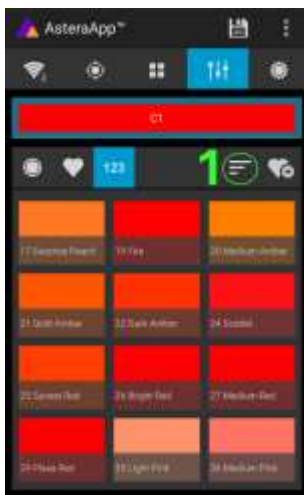

The "123" button offers common color gels. Hit the sort button to sort by color or number (1).



To add a color to the favorites, press (2). To edit an existing favorite color, select it and press the pen (1).

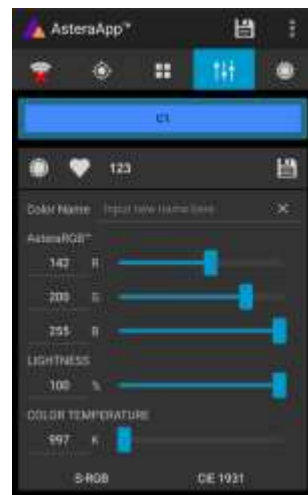

The editor will open. RGB values can be adjusted directly. Also a color temperature can be converted to RGB.

7.4 CREATE A SET

Before the more powerful effects can be reviewed, it is recommended to create a Flow-Set first.

Each light can be assigned to one set. Two types of sets are available:

7.4.1 SYNC SET

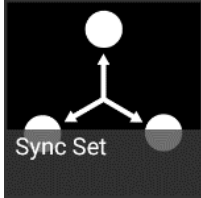

All lights that are assigned to a Sync-Set can be controlled together. They will do exactly the same.

CREATE A SYNC-SET:



On the AsteraApp™ main screen, first press the Targets button (1) and then the "+" sign (2) to add a new target.



Choose "Sync-Set".

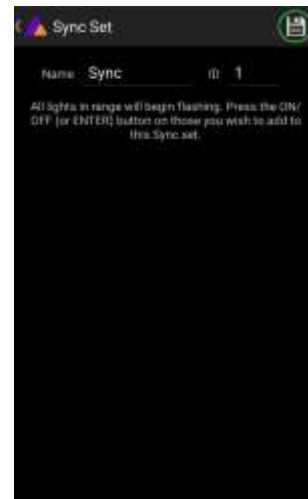

Now all lights will flicker every two seconds. Tap your light to add it to the set (chapter 6.7 **Error! Reference source not found.**).

Additionally, the name of the set can be customized. When finished, press the save button.

7.4.2 FLOW SET

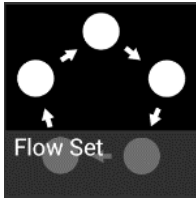

By using a Flow-Set, lights can also be controlled together. But additionally, they are assigned to positions inside the Flow-Set and so form a virtual light with several pixels. All effects, like a running light, are stretched over this virtual light.

CREATE A FLOW-SET:



On the AsteraApp™ main screen, first press the Targets button (1) and then the "+" sign (2) to add a new target.

Then choose "Flow-Set".



Each flow set can have up to 32 positions. Once the correct number is entered, press "Confirm".

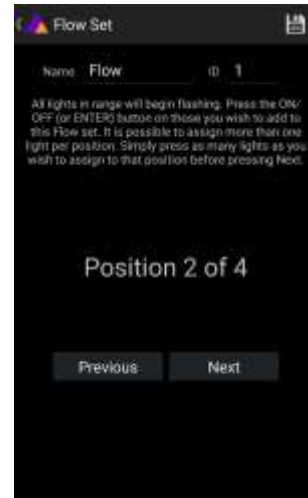

Now your lights will flicker every two seconds. To add a light to the currently shown position of this set, press its button. Walk through the positions by "Previous" and "Next" and assign your lights. When finished, press the save button on top.

7.5 TARGETING LIGHTS

Once you have created a set, you may now choose to control it. By default "All lights" are targeted. That includes all sets.

It is possible to target more than one set at a time.

NOTE:

Even while targeting „All Lights“ the Flow-Sets position arrangements persist. The lights still form a virtual big light of several positions.

To modify, delete or arrange targets, use the pen button (1).

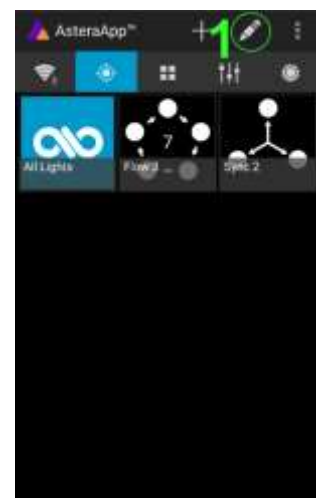

7.6 CHANGING THE EFFECT



On the AsteraApp™ main screen, press “Wedding” (1), then enter the editor (2).



Set “Crossfade” to 0% and “Speed” to around 2 seconds. You should see a clean running light now. The White light will run over a pink background.



The effect can be changed by sliding the effect picker and choosing a sub-effect below it. Again the colors can be adjusted, too.

After the effect is adjusted, it may be saved back to the main screen by pressing the save button.

AN EFFECT CAN BE HIGHLY CUSTOMIZED:



The speed tells how long it will take for the effect to complete one cycle.



The crossfade tells if the light will fade from step to step. If it is set to 0% an immediate change is visible. If set to 100% the changes will be soft.

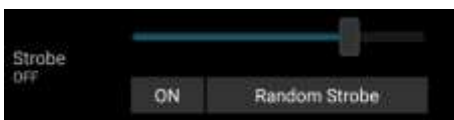









Stroboscope effect can be enabled and seamlessly adjusted in speed. Additionally, three random stroboscope options are available: slow, medium and fast.

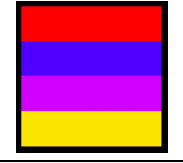

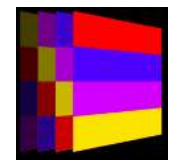
Each effect can be adjusted in brightness as well.

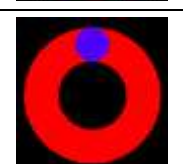
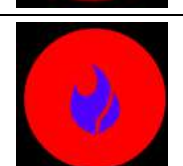
7.7 LIST OF EFFECTS

The effects' patterns are pre-defined and cannot be modified by the user. They are pre-programmed inside of each light. Still they can be parameterized. These effects are:

	<p>A static color is displayed. There are also options that show two, three or four static colors at a time. The Flow-Set is then divided into several parts of equal length:</p> 
	<p>Fading colors. The four defined colors are displayed one after the other. The setup fade is applied between them. Again, the Flow-Set can be split in up to four segments.</p>
	<p>From both sides of a Flow-Set, the color changes position by position from C1 to C2. Once the whole Set is C2, it changes back to C1 in the same way.</p>
	<p>The color of the Flow-Set changes position by position. After all positions show the same color, a new cycle is started.</p>
	<p>Several variations of running lights are available.</p>
	<p>The Fire effect shows a random flickering effect. The background color and the color of the flickering effect can be adjusted.</p>
	<p>The rainbow effect shows a color change through all colors. Only its speed can be adjusted.</p>
	<p>Chaser effects provide an efficient means to create dancefloor lighting. The static chaser exchanges the color of the lights according to the tapped-in beat. The colors are randomly chosen. The effect can be adjusted to show up to 4 different colors at a time.</p>
	<p>The Moving Chasers overlay the static chaser by a second movement of the four displayed colors over the available positions of a Flow-Set. This gets mostly interesting if the Moving Strobe is chosen. Then, only some of the positions strobe and they are moving. So the strobe effect moves over the Flow-Set.</p>
	<p>When using the Chaser With Background, additionally a color can be selected that is mostly used, the background color.</p>

7.8 CHASER EFFECTS IN DEEP

To display chaser effects it is recommended to setup a Flow-Set with a multiple of four positions. This is the way they will be shown best. Those four positions could then be arranged in the corners of a dance floor for example.

Use the tap-sync button to tap the beat of the music; the Chaser Effects will base their color changing on that beat then.

The Chaser Effects offer additional controls



The Emphasis adjusts the way the colors are exchanged by the chaser:

Emphasis	Effect
-2	The four colors of the palette are exchanged one by one. Every beat changes only one color.
-1	Same as "-2", but the color change is animated with the color-wheel effect; it mimics the color change of a traditional color wheel, showing intermediate colors during the change.
0	All four colors are exchanged on every beat.
1	Same as "0", but the color wheel effect is added.
2	Same as "0", but on the fourth beat, all colors go black. They come on again on the next beat.
3	Same as "0", but all colors go black on every second beat. This setting produces a strong on-off effect in sync with the beat.



The softness influences the fading between colors that happens on every beat. 0% will generate a hard change of the colors, while 100% makes them fade very slowly.



A random button is added to the color bar. If it is latched, random colors are chosen on every beat. If not (like in the above picture), then the colors are always chosen randomly from the color pallet of four. This is useful to intentionally narrow down the color choice. Nice effect can be generated by setting some of them to black.

7.9 THE MAIN SCREEN

Here each program is represented by a file. Those files can be edited and freely positioned. Several pages of files are available.



To move or delete a file, press the pen icon (2). A popup will show the available actions. To add a new program tile, press the "+" icon (1).

While adding a file, either a default "Static Red" or the currently running program can be selected. Additionally, special function tiles are available.

7.9.1 Function Tiles



Tapping this tile several times to the beat will let the Chaser Effects change their colors to the beat. A chaser effect has a dancer symbol on the tile.



This button can be used to quickly blackout lights. The currently set target must be observed, as the blackout function will only affect the currently targeted lights.

7.10 BRIGHTNESS

Additionally to each programs brightness slider mentioned in chapter 7.6, a master brightness control is available.

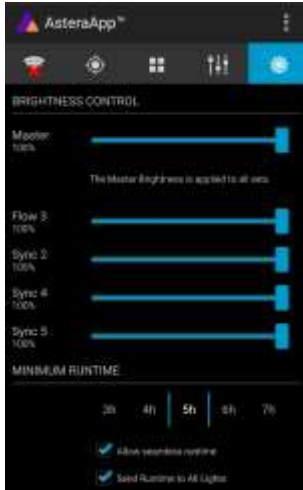

As soon as more than one Set is created and at least one set is currently targeted, a sub-master for each Set is shown.

Otherwise, only one slider is available. It controls the brightness of all currently targeted lights.

7.10.1 Set Sub-Masters

Each Set has its own brightness slider. Additionally, there is a master slider that controls the brightness of all Sets simultaneously. This is very similar to the group brightness control of common lighting desks.

NOTE:

The Set-Masters are only shown if:

- a) More than one Set has been created before
- b) Only Set-Targets are currently selected. Selecting any other type of target, like "All Lights" will hide the Set-Masters. This is necessary to avoid that one lights gets redundant brightness information; it would flicker constantly between different brightness levels.

7.11 RUNTIME

The light is able to adjust its power to meet a certain runtime on battery. The runtime is always calculated for a full battery.

Example:

If the light is required to light during an eight hour event, and one hour of setup time is scheduled, then the runtime should be set to nine hours immediately after the first power up.

Please note, that the light should not be stored below 20°C before an event, otherwise the runtime might be shorter than calculated.

More details on the built in battery can be found at chapter 3.2.



7.12 ANTI-FLICKER

The PWM refresh rate of this light is 599.4 Hz by default. This frequency can be freely adjusted between 200 Hz and 1205 Hz to fit different camera's frame rates.



Make sure you have targeted the lights you wish to adjust (chapter 7.5). Then press the "Anti-Flicker".



Slide the "fps" to adjust to default values for a framerate. Slide the "Hz" to fine-adjust.



Press the highlighted frequency to enter a custom value between 200 and 1205 Hz.

NOTE:

The Anti-Flicker adjustment is preserved in case the lamp is powered off. It is set back to the default 599.4Hz once a Reset Settings (chapter 6.19) is done. The adjusted frequency is used no matter what input source is currently active. Also during DMX operation.

7.13 THEFT ALARM

Your light is equipped with a theft alarm. A motion sensor in the light detects when it is moved/taken away and a small siren will sound to deter potential thieves.



First make sure your Radio Pin is different from 0000. See chapter 7.1 how to change it. Then press the "ON" button.

Press "Activate". All targeted lights will flash shortly to indicate that they are now armed.

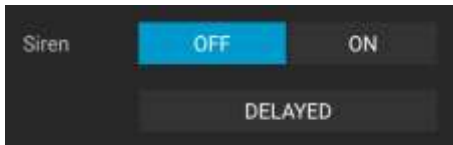

If the siren is set to DELAYED, it sounds only if the alarm persists for more than 6 seconds. The ON setting makes it sound immediately, while the OFF setting mutes it always.

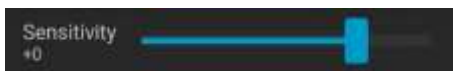

The sensitivity can be adjusted to meet your environment. A lower value makes a false alarm more unlikely.

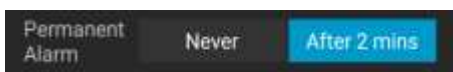

In case a potential thief is taking the light away while ignoring the alarm, he will most likely cause alarm events for more than 2 minutes in a row. In that case, the alarm can be set to become permanent. Then it won't stop, even if the light is placed down again. It will run until the battery is empty, rendering the light useless for the thief.

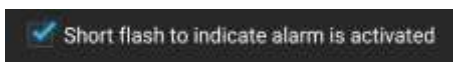

In some applications it is not desirable to have the lights flashing while the alarm is enabled or disabled. It can be disabled by this option easily.



The alarm can be silenced without turning it off by pressing this button.

NOTE:

To turn the alarm off again, an AsteraApp™ with the same Radio Pin must be used. Do not forget your Radio Pin! Otherwise, your light cannot be used normally anymore.

7.14 ENTER AND LEAVE STANDBY

The standby is intended to be used between setup and event (see chapter 3.2.1 **Error! eference source not found.**). After setup is completed, all lights may be switched to standby mode and woken up later when the event starts. This ensures that no battery runtime is wasted. This can be either done manually or automated.



Press the small arrow to open the standby menu.

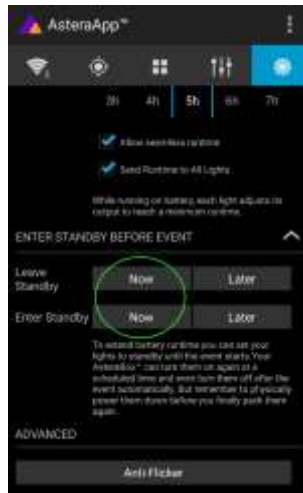

By pressing the "Now" buttons, standby can be switched on or off for all currently targeted lights.



Any of the "Later" buttons will require a time to be set. The standby will be scheduled to the specified time.

NOTE:

While you are using the "Now" function, only those lights that are currently targeted are addressed (see chapter 7.5 how to target lights).

The "Later" function always sends to the "All Lights" target!

7.15 DMX SETTINGS

In order to efficiently use the light with DMX, some setting can be adjusted by the AsteraApp™.

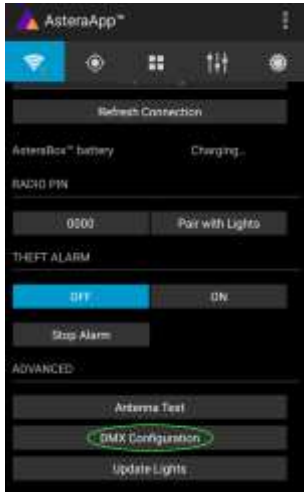

Press the “DMX Configuration” button.



Adjust all settings to your requirements, then press “Send”.



Your lights will start to flicker. Tap the lights you wish to setup (chapter 6.7). Then press “Done”.

Please refer to chapter 6.10, *INPUT SELECT*, and chapter 6.12, *DMX Settings*, for details on the available settings.

7.15.1 DMX Channel Assignment

The current channel assignment can be always reviewed in the lower part of the screen. It is automatically calculated based on the setting of Table and Strobe.

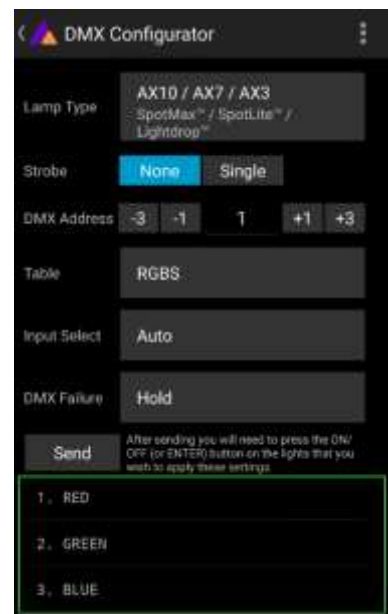



8 MENU OVERVIEW

